

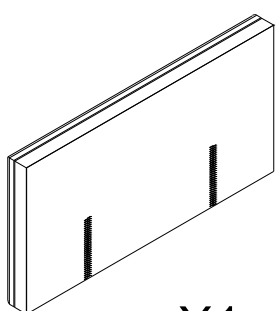

HEADBOARD ASSEMBLY INSTRUCTIONS

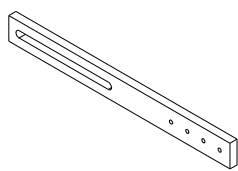

X1



X2

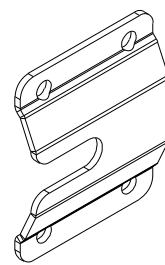

X2

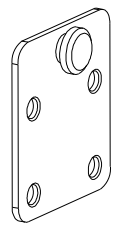

X2

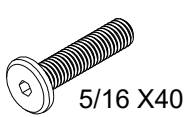

5/16 X40

X4

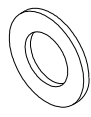

X4

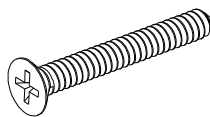

X16



X8

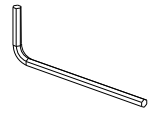

X1



HEADBOARD ASSEMBLY INSTRUCTIONS

Bed mounting option

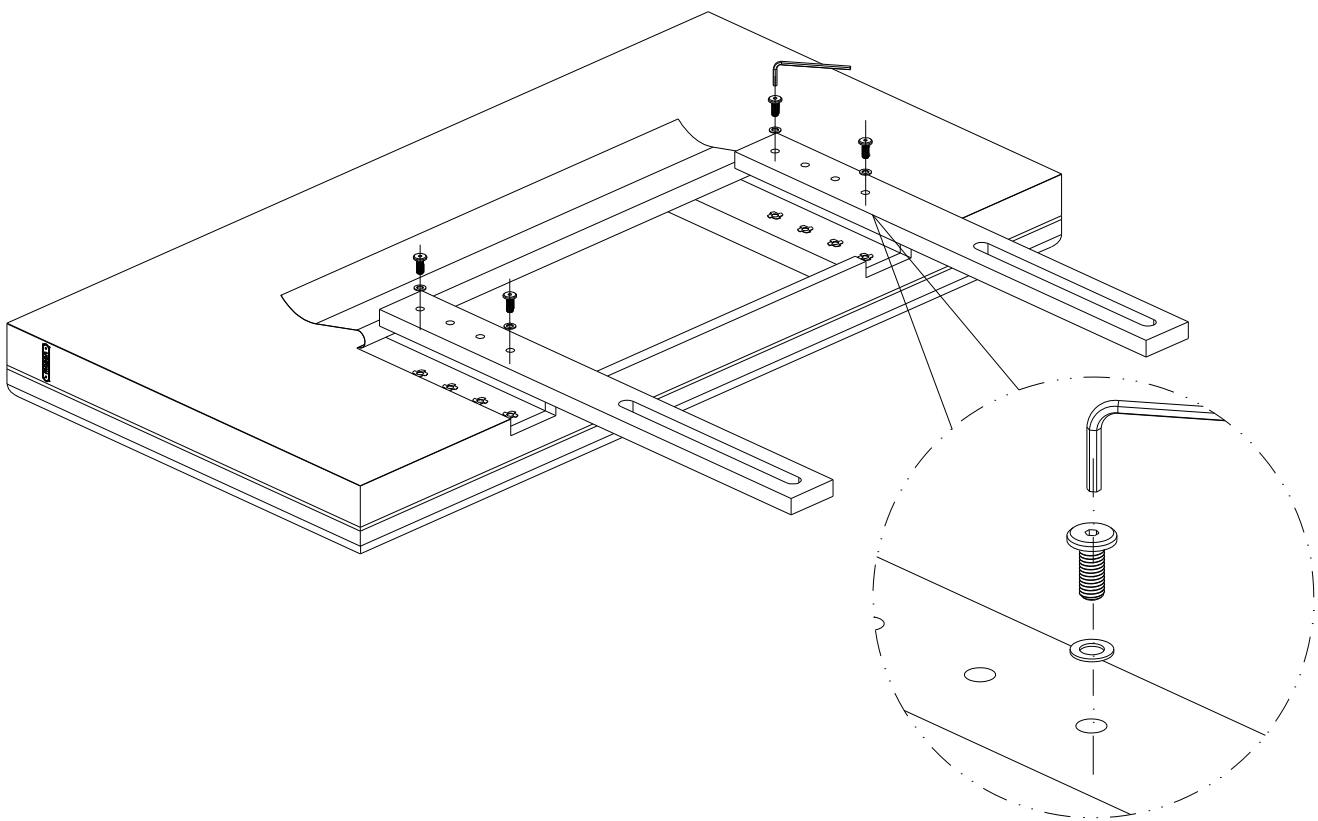

Wall mounting option

